

汽车起重机 / Truck Crane

QY50KA

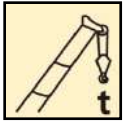

50 t



43.5 m

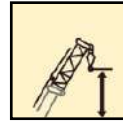

58.1 m



XCMG official Pte Ltd
www.machmall.com
machmall@xcmg.com

QY50KA广泛适用于建筑工地、城市改造、交通运输、港口、桥梁、油田、矿场等场所和其它复杂的作业环境

QY50KA Truck crane is widely used for the lifting operations in general engineering projects, such as construction site, urban renewal, communication and transportation, ports, bridge, oilfields and mine, and complex working environments.



QY50KA

- 五节“U型”43.5米主臂，最大起重能力：50吨，最大起升高度：58.1米，最大工作半径：43.9米，性能全面领先
- 5-section boom of 43.5m with U-type profile is adopted; the max. lifting load is 50 t; the max. lifting height is 58.1 m; the max. working radius is 43.9 m; The performance takes the lead comprehensively.



QY50KA







回转机构

Slewing mechanism

- 单排四点接触球外齿式回转支承，360度回转
- Single-row four-point ball contact external tooth slewing ring, may continuously slew 360°.
- 定量泵-定量马达液压系统
- A constant displacement pump and motor Hydraulic system
- 具有动力控制或自由回转的功能，可无级调速
- Power control and free-sliding function are available, and speed may be infinitely regulated
- 回转速度为0-2r/min
- Slewing speed 0-2r/min





超强起重性能

Super lifting performance

- 行业最长五节 43.5 米 “U 型” 主臂，主吊钩最大 12 倍率，性能领先同类产品 3-10%；
- 5-section boom of 43.5m with U-type profile is the longest of the same class in the industry; the max. parts of line is 12 for the main hook block. The performance is 3-10% higher than that of the competitors；



新型节能液压系统

New energy-saving hydraulic system

- 卷扬起落、伸缩伸、变幅起均采用双泵合流技术，变幅、伸缩作业效率全面领先对手The min. stable slewing speed is 0.1°/s. The min. stable lifting speed (drum) is 2.5m/min. Precise and safe lifting movements can be realized.

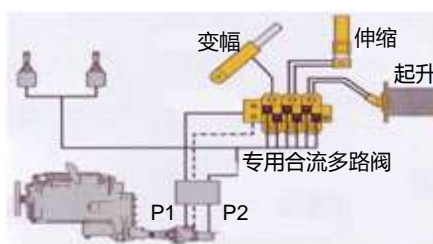

起升机构

Hoisting mechanism

- 定量泵-定量马达开式液压系统
- The open winch hydraulic system consisting of displacement pumps and constant displacement motors
- 行星齿轮减速器、常闭式制动器
- Planetary gear reducer, normally closed brake
- 最大单绳拉力为48KN
- Max. single line pull 48KN
- 最大起升速度130m/min
- Max. hoisting 130m/min

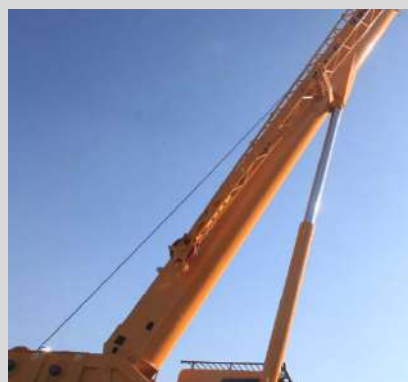

变幅机构

Elevating mechanism

- 单变幅油缸，可靠性高
- Single elevating cylinder, high reliability
- 使用带负载补偿功能的变幅平衡阀
- The elevating balance valve with load compensation function

QY50KA



动力传动系统

Drive train

- 重汽发动机，额定功率276kw，最大输出扭矩1560N.m
- Heavy truck group engine, rated power 276kw, max. torque 1560N.m
- 陕齿机械变速箱，软轴操纵，全同步器
- Mechanical transmission made by Shanxi Gear Factory, with synchronizer. It is manually operated through flexible shaft.
- 最高车速80Km/h，最大爬坡能力42%
- Max. travel speed 80Km/h, Max. grade ability 42%





行驶性能全面领先

Low-speed large-torque power drive system

- 动力强劲：黄金传动链，发动机、变速箱成熟可靠，爬坡能力强；
- Strong power : gold drive system , reliable engine、 gearbox , strong ability on climbing.
- 超强通过性能：接近角、离去角、支脚盘离地间隙行业领先；
- Strong passing ability : approach angle、 departure angle、 distance of plate and ground leading industr.

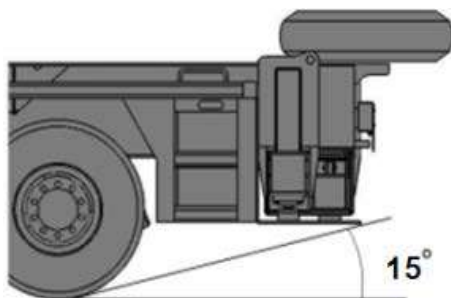
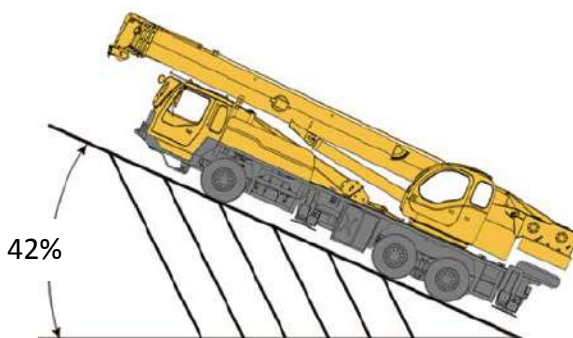

悬挂系统

Suspension system

- 前悬架采用钢板弹簧
- The front suspension consists of leaf springs
- 后悬架采用橡胶悬架，V型推力杆
- The rear suspension consists of rubber suspension and V-type thrust bars,



制动系统

Pneumatic disc brake

- 脚踏板操纵的双回路气压制动。一轴为盘式制动器，二、三轴为鼓式制动器
- Foot pedal operated double-circuit air pressure brake. The disc brakes are used for the first axle, drum brakes are used for the 2nd and 3rd axles.
- 驻车制动：弹簧储能制动，作用于2、3轴车轮。
- Parking brake: spring energy brake, acting on wheels of 2,3 axles.
- 辅助制动：发动机排气制动、发动机缸内缓速制动
- Auxiliary brake : engine exhaust brake+ engine compression brake.

QY50KA



驾驶室

Driver's cab

- 钢结构全宽豪华驾驶室，全封闭，密封性好，防腐蚀、软化内饰，装备豪华舒适。
- Full-dimension luxurious driver's cab with steel structure, full closed, good sealing performance , anti-corrosion , and softening the interior.
- 配置收音机、可调式座椅、简易卧铺、方向盘、安全玻璃、3只雨刷器、电动后视镜、电动门窗升降器、杂物箱。
- Equipped with radio, adjustable seats, simple sleeper , steering wheel, safety glasses, electrically controlled windshield washer, electrically operated rearview mirror, electrically operated door window and glove box.



新型外观造型与人性化设计

New appearance and humanized design

- 新一代外观设计，整机刚劲有力，时尚的驾驶室与操纵室新外观，层次感与力量感完美结合；全面的人体工程学分析，人性化细节处理，打造驾驶轻松、操纵舒适，维护便捷的内在品质
- A new generation of appearance design makes the whole vehicle powerful and vigorous; Fashionable outlines of driver's cab and operator's cab bring perfect combination of sense of layers and sense of physical strength; ergonomics analysis and humanized details make inherent quality of easy driving comfortable operation and convenient maintenance

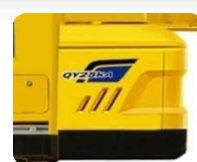

操纵室

Operator's cab

- 新型钢制操纵室，装有无视野死角的前景窗，安全玻璃，车窗装有遮阳板，推拉式车门，带推拉踏板，方便人员进出。
- New fully-enclosed steel operator's cab with a full-view front window. Safety glass and sun shield are used for windows. Wipers are fitted for the windshield and roof window. A sliding door and a pull-out step are available.
- 座椅靠背可倾斜定位，操纵杆安装在座椅两侧的扶手上
- The cab features a new ergonomic seat design with backrest adjustment and armrests with joysticks fitted.
- 标配冷暖空调
- Air conditioner are available.



机棚和发动机罩

engine hook and cover

- 外观新颖，整机外观线条流畅。
- the crane has novel appearance, streamlined and elegant outline
- 散热优、维修方便。
- Good heat dissipation and convenient maintenance



铝合金燃油箱

aluminium alloy fuel tank

- 外观质量好，耐腐蚀性能强
- Good appearance quality and strong corrosion resistance.

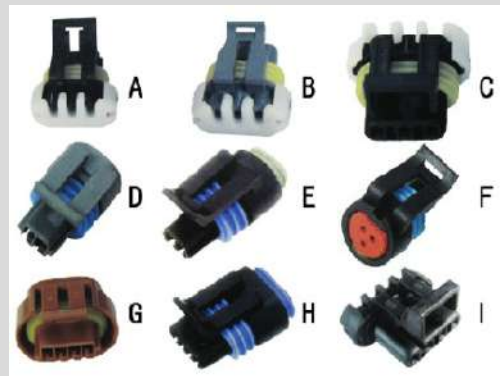

新型外观造型与人性化设计

New appearance and humanized design

- 全覆盖式走台板，铝合金型材，品质感强，独立式轮包，层次丰富；
- Fully covered aluminum alloy deck, strong sense of quality; independent wheel fender, sense of plentiful layers;
- 铝型材防护栏，表面质量高、防腐性能强；
- Guard rails made of aluminum alloy, high quality and strong anti-corrosion capacity;
- 全新人机设计把手和扶梯，精良考究工艺制造，攀爬方便可靠。
- Ergonomically designed hand holds and hand rails, made by fine manufacture process, convenient and reliable for climbing.



高可靠性元器件

More reliable component

- 防水插接件，接插件内部带橡胶护套，防水性能极佳，防护等级达到IP65。
- Waterproof component ,defend grade IP65.
- 铝合金燃油箱，外观质量好，耐腐蚀，抗冲击能力强。
- Aluminium alloy oil tank,appearance beautiful,better corrosion resistance,better shock resistance.



助力换挡

Power boosted shifting

- 换挡力小，换挡行程短，
- Power boosted shifting with shorter shifting stroke and improved comfort.
- 即使系统出现故障，仍可进行正常机械换挡
- Even if fault occurs, mechanical shifting can still be realized